

BUBLIING M





TECHINICAL SPECIFICATIONS





Flexibility, at its core.

Offering solutions for a variety of needs, this model is the most flexible, ideal for holding small meetings for two or having a complete workspace at your disposal.

-  A space for 2 people
-  Class A soundproofing
-  Guaranteed privacy and comfort
-  Automatic ventilation and lighting

BUBLING M | TECHNICAL SPECIFICATIONS

GENERAL DESCRIPTION

Dimensions	<p>Exterior: 2006x1006x2245 mm / 78,98x39,61x88,39 in</p> <p>Optional with wheels: Additional 52 mm / 2,05 in</p> <p>With Bubling Fresh Air: Additional 50 mm / 1,97 in</p> <p>Interior: 1708x974x2060 mm / 67,24x38,35x81,10 in</p> <p>Entrance height: 86 mm / 3,39 in ; With casters: 138 mm / 5,43 in</p> <p>The door: 2108x774 mm / 82,99x30,47 in</p>
Standard weight	510 kg / 1124 lb
Acoustic	<p>Class A DB,A >30 dB</p> <p>Guaranteed speech level reduction according to the ISO 23351-1 testing method, with one of the best ratings in the industry.</p>
Fan airflow	<p>Airflow: 560,8 m³/h (2 fans)</p> <p>The air is renewed, on average, every 5,6 minutes.</p> <p>The airflow can be manually adjusted.</p> <p>In standby mode, the system activates for 10 minutes per hour.</p>
Lighting	<p>Ceiling light: LED lighting with a temperature of 3500 K - 4000 K, providing up to 500 lux on the desk.</p> <p>The lighting is automatic and can be manually adjusted.</p>
Occupancy indicators	LED sensor technology with red or green light indicator.
Mobility	<p>High-resistance adjusters accessible from inside the cabin.</p> <p>The BUBLING is prepared to accommodate casters (optional).</p> <p>The adjusters must be lifted to move the cabin and retracted when in the desired position.</p>

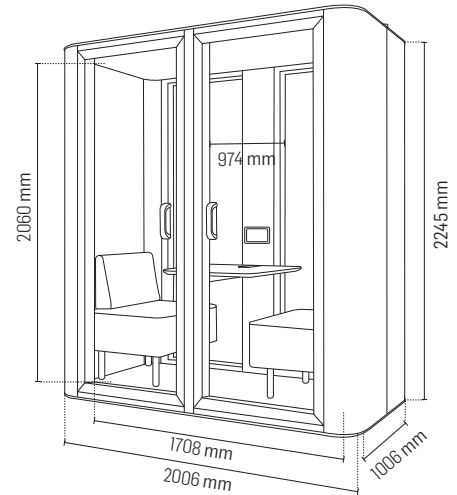

MATERIALS

Exterior	<p>Exterior panels: Made of thermocoated steel, replaceable in 10 available colors.</p> <p>Frame and door: Made of aluminum coated in matte black RAL 9005, with an invisible pivot hinge.</p> <p>Handle: Made of textured black polymer.</p> <p>Glass: Clear acoustic glass, 8 mm / 0.31 in.</p>
Interior	<p>Structure: Metal frame, wood, and recycled acoustic foam.</p> <p>Upholstery: 100% polyester fabric available in 12 colors.</p> <p>Flooring: 100% polyamide carpet available in 4 colors.</p> <p>Table: Top and lower box made of birch plywood covered with white, fingerprint-resistant black laminate, or wood imitation laminate.</p>
Standard furniture	<p>Table dimensions: 745x700x730 mm / 29.33x27.56x28.74 in</p> <p>Table height: 730 or 1050 mm / 28.74 or 41.34 in</p> <p>Maximum load for the table is 50kg / 110.23 lbs</p> <p>Sofa dimensions: 730x570x810 mm / 28.74x22.44x31.89 in</p> <p>Sofa upholstered in 100% polyester fabric, available in 12 colors.</p> <p>Clothes hangers (2): coated in textured black RAL 9005.</p>
Furniture options	<p>High stool: 400x400x580-780 mm / 15.75x15.75x22.83-30.71 in</p> <p>These optional items are upholstered in 100% polyester fabric, available in 12 colors.</p>

With sofa:

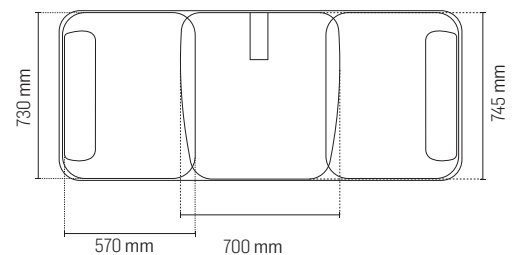

With high stool:

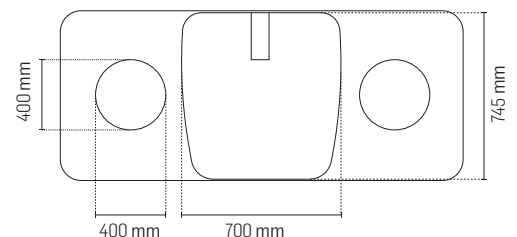

BUBLING M | TECHNICAL SPECIFICATIONS

SAFETY

Fire protection All coating materials, upholstery, and acoustic materials used in our products are tested and classified according to national or international standards.

Fabrics: EN 13501-1 Adhered Class B, s1, d0
Foams: ISO 3795
Carpet: EN 13501-1 CfL – s1
Wood: EN 13986, Class D-s2, d0

Earthquake resistance The BUBLING can be supplied with a system that allows fixation to the floor, available for seismic regions.

ENERGY

Electrical equipment 2x Schuko sockets - 230 V
1x USB-C port
1x USB-A port
Optional: RJ45 network socket; HDMI port.

Standard consumption 60 W

Standby consumption 0,74 W

Equipment power AC output (electrical socket); 100-240 VAC, 16 A, 50-60 Hz.

Charger output USB-C output 18 W

EXTRA FEATURES

Options

- | 7-inch manual control screen.
- | Metal hydraulic air spring for door closure.
- | High-capacity load casters. The adjustment of the casters and leveling feet is done from inside the BUBLING.
- | **Bubliing Fresh Air** system, non-adjustable and noise-free.
- | **Internal metal monitor support** with VESA mounting. Monitor not included. Maximum monitor size is 32/42 inches.

SPACE AND INSTALLATION

Required space Depth of the BUBLING: 1006 mm / 39.61 in + 100° door opening. Minimum recommended space for air circulation above and on the sides: 150 mm / 5.91 in.

Installation space The installation requires 500 mm / 19.69 in of free space around the BUBLING.

Assembly **Assembly time:** 1 hour
Number of people: 2 people

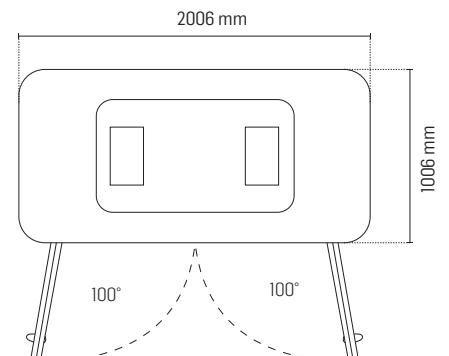

BUBLIING M | STANDARD FURNITURE



LOW TABLE
745x700x730 mm
29,33x27,56x28,74 in



SOFAS
730x570x810 mm
28,74x22,44x31,89 in



CLOTHES HANGERS
2 units

BUBLIING M | OPTIONAL FURNITURE



HIGH TABLE
745x700x1050 mm
29,33x27,56x41,34 in



HIGH STOOL
400x400x580-780 mm
15,75x15,75,39x22,83-30,71 in

BUBLIING M | STANDARD FEATURES



CONNECTIVITY

2x standard Schuko sockets - 230 V
1x USB-C port
1x USB-A port



DIMMER SWITCH

Intensity regulator for lighting and ventilation.

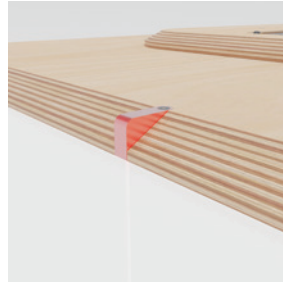

OCCUPANCY INDICATOR

Tecnologia a sensore LED per esterni.
2 unità.

BUBLIING M | OPTIONAL FEATURES



CASTERS

High load capacity. Adjustment is made from the inside.



AIR SPRING

Metal hydraulic for door.



CONTROL SCREEN

7-inch manual control.



SOFA CUSHION

Covered with 100% polyester fabric.
12 colors available.



INTERNAL MONITOR SUPPORT

Monitor not included.
Maximum size: 32/42 inches.



BUBLIING FRESH AIR

Non-adjustable system.
Noise-free.



BUBLING M | FINISHES





INTERIOR FINISH

 Beige CSE01	 Light Blue CSE38
 Light Gray CSE41	 Navy Blue CSE40
 Charcoal Gray CSE13	 Coral Red CSE24
 Brown Beige CSE02	 Classic Red CSE29
 Tea Green CSE33	 Yellow CSE03
 Olive Green CSE34	 Mustard CSE31

EXTERIOR COATING

 White RAL 9003 MATE	 Dark Blue RAL 5001 MATE
 Light Gray RAL 9002 MATE	 Light Blue RAL 5014 MATE
 Dark Gray RAL 7039 MATE	 Dark Green RAL 6028 MATE
 Black RAL 9005 MATE	 Light Green RAL 6021 MATE
 Red Beige RAL 3012 MATE	 Beige RAL 1001 MATE

INTERIOR FLOORING

 Beige 393100
 Brown 327260
 Dark gray 393350
 Light Gray 393300

TABLETOP

 Plywood with white laminated	 Plywood with anti-fingerprint black laminated	 Plywood with oak laminated
---	---	---

Due to the different configurations of monitors and printers, the appearance of the finishes may vary from the actual finish. To ensure that the chosen finishes meet your expectations, please refer to physical samples or contact a BUBLING representative.

