

BUBLIING S

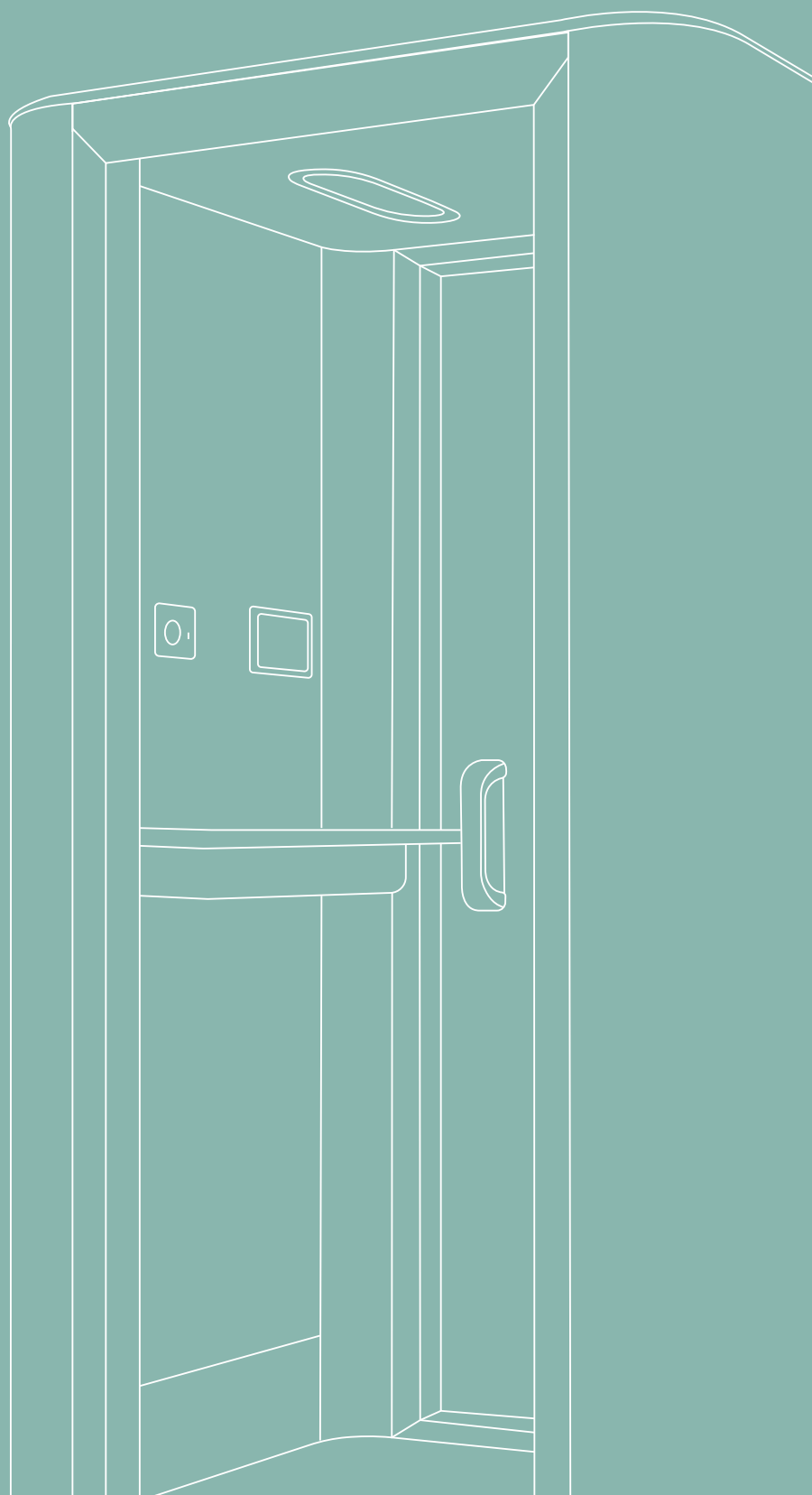



TECHINICAL SPECIFICATIONS





Small in size, huge in solutions.

Being the smallest of all the models, it is perfect for providing you with complete privacy for your phone calls, video conference meetings, or other small individual tasks.

-  Space for individual use
-  Class A soundproofing
-  Guaranteed privacy and comfort
-  Automatic ventilation and lighting

BUBLING S | TECHNICAL SPECIFICATIONS

GENERAL DESCRIPTION

Dimensions	<p>Exterior: 1206x1006x2245 mm / 47,48x39,61x88,39 in Optional with wheels: Additional 52 mm / 2,05 in With Bubling Fresh Air: Additional 50 mm / 1,97 in Interior: 914x974x2060 mm / 35,98x38,35x81,10 in Entrance height: 86 mm / 3,39 in ; With casters: 138 mm / 5,43 in The door: 2108x825 mm / 82,99x32,48 in</p>
Standard weight	360 kg / 794 ib
Acoustic	<p>Class A DB,A >30 dB Guaranteed speech level reduction according to the ISO 23351-1 testing method, with one of the best ratings in the industry.</p>
Sound production	<p>Sound impact produced by the ventilation system. Interior: 36 dB at head height. Exterior: 25 dB at a distance of 1 meter. Test conducted according to ISO 11201:2010.</p>
Fan airflow	<p>Airflow: 280.4 m³/h (2 fans) The air is renewed, on average, every 5,6 minutes. The airflow can be manually adjusted. In standby mode, the system activates for 10 minutes per hour.</p>
Lighting	<p>Ceiling light: LED lighting with a temperature of 3500 K - 4000 K, providing up to 500 lux on the desk. Facial light: LED lighting with a temperature of 3500 K - 4000 K, providing up to 500 lux on the user's face. The lighting is automatic and can be manually adjusted.</p>
Occupancy indicators	LED sensor technology with red or green light indicator.
Mobility	<p>High-resistance adjusters accessible from inside the cabin. The BUBLING is prepared to accommodate casters (optional). The adjusters must be lifted to move the cabin and retracted when in the desired position.</p>

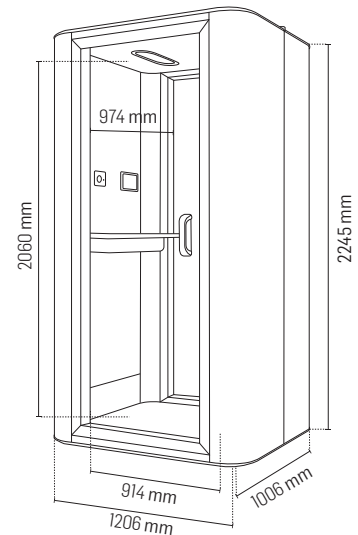

MATERIALS

Exterior	<p>Exterior panels: Made of thermocoated steel, replaceable in 10 available colors. Frame and door: Made of aluminum coated in matte black RAL 9005, with an invisible pivot hinge. Handle: Made of textured black polymer. Glass: Clear acoustic glass, 8 mm / 0.31 in.</p>
Interior	<p>Structure: Metal frame, wood, and recycled acoustic foam. Upholstery: 100% polyester fabric available in 12 colors. Flooring: 100% polyamide carpet available in 4 colors. Table: Top and lower box made of birch plywood covered with white, fingerprint-resistant black laminate, or wood imitation laminate.</p>
Standard furniture	<p>Table dimensions: 730x400x1050 mm / 28.74x15.94x41.34 in Table height: 730 or 1050 mm / 28.74 or 41.34 in Maximum load for the table is 50 kg / 110.23 lbs Clothes hanger: coated in textured black RAL 9005.</p>
Furniture options	<p>Sofa: 730x570x810 mm / 28.74x22.44x31.89 in High stool: 400x400x580-780 mm / 15.75x15.75x22.83-30.71 in Backrest: 570x145x760 mm / 22.44x5.71x29.92 in These options are upholstered in 100% polyester fabric, available in 12 colors. The maximum load for the seat is 135 kg / 297.12 lbs.</p>

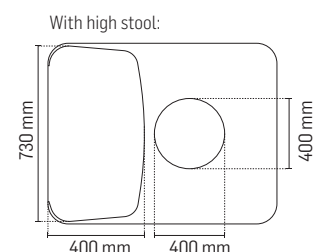
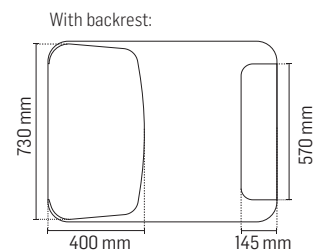
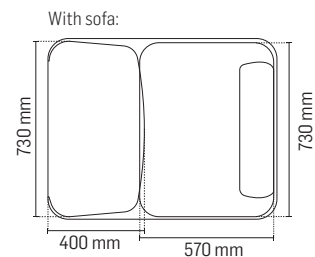

BUBLING S | TECHNICAL SPECIFICATIONS

SAFETY

Fire protection	All coating materials, upholstery, and acoustic materials used in our products are tested and classified according to national or international standards. Fabrics: EN 13501-1 Adhered Class B, s1, d0 Foams: ISO 3795 Carpet: EN 13501-1 Cfl – s1 Wood: EN 13986, Class D-s2, d0
Earthquake resistance	The BUBLING can be supplied with a system that allows fixation to the floor, available for seismic regions.

ENERGY

Electrical equipment	1x Schuko socket - 230V 1x USB-C port Optional: USB-A port.
Standard consumption	30 W
Standby consumption	0,74 W
Equipment power	AC output (electrical socket); 100-240 VAC, 16 A, 50-60 Hz.
Charger output	USB-C output 18 W

EXTRA FEATURES

Options	<ul style="list-style-type: none"> 7-inch manual control screen. Metal hydraulic air spring for door closure. Invisible wireless charger on the desk. High-capacity load casters. The adjustment of the casters and leveling feet is done from inside the BUBLING. Adjustable facial light up to 500 lux on the user's face. Bubliing Fresh Air system, non-adjustable and noise-free. Sofa cushion upholstered in 100% polyester fabric, available in 12 colors. Adjustable height desk system with a range of 730-1200 mm / 28.74x47.24 in.
----------------	--

SPACE AND INSTALLATION

Required space	Depth of the BUBLING: 1006 mm / 39.61 in + 100° door opening. Minimum recommended space for air circulation above and on the sides: 150 mm / 5.91 in.
Installation space	The installation requires 500 mm / 19.69 in of free space around the BUBLING.
Assembly	Assembly time: 30 minutes Number of people: 2 people

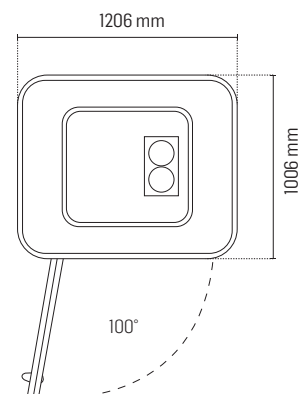

BUBLING S | STANDARD FURNITURE



HIGH TABLE
730x400x1050 mm
28,74x15,75x41,34 in



CLOTHES HANGER
1 unit

BUBLING S | OPTIONAL FURNITURE



LOW TABLE
730x400x730 mm
28,74x15,75x28,74 in



SOFA
730x570x810 mm
28,74x22,44x31,89 in



HIGH STOOL
400x400x580-780 mm
15,75x15,75x22,83-30,71 in



BACKREST
570x145x760 mm
22,44x5,71x29,92 in

BUBLING S | STANDARD FEATURES



CONNECTIVITY

1x presa standard Schuko - 230 V
1x ingresso USB-C



DIMMER SWITCH

Intensity regulator for lighting and ventilation.

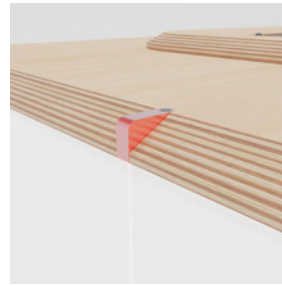

OCCUPANCY INDICATOR

Tecnologia a sensore LED per esterni.
2 unità.

BUBLING S | OPTIONAL FEATURES



CASTERS

High load capacity. Adjustment is made from the inside.



AIR SPRING

Metal hydraulic for door.



WIRELESS CHARGER

Invisible charger on the desk.



CONTROL SCREEN

7-inch manual control.



FACIAL LIGHT

LED lighting 3500 K - 4000 K.
Up to 500 lux on the user's face.



LIFTING TABLE

Height adjustable system:
730-1200 mm / 28.74x47.24 in.



SOFA CUSHION

Covered with 100% polyester fabric.
12 colors available.



BUBLING FRESH AIR

Non-adjustable system.
Noise-free.



BUBLIING S | FINISHES





INTERIOR FINISH

 Beige CSE01	 Light Blue CSE38
 Light Gray CSE41	 Navy Blue CSE40
 Charcoal Gray CSE13	 Coral Red CSE24
 Brown Beige CSE02	 Classic Red CSE29
 Tea Green CSE33	 Yellow CSE03
 Olive Green CSE34	 Mustard CSE31



EXTERIOR COATING

 White RAL 9003 MATE	 Dark Blue RAL 5001 MATE
 Light Gray RAL 9002 MATE	 Light Blue RAL 5014 MATE
 Dark Gray RAL 7039 MATE	 Dark Green RAL 6028 MATE
 Black RAL 9005 MATE	 Light Green RAL 6021 MATE
 Red Beige RAL 3012 MATE	 Beige RAL 1001 MATE

INTERIOR FLOORING

 Beige 393100
 Brown 327260
 Dark gray 393350
 Light Gray 393300

TABLETOP

 Plywood with white laminated	 Plywood with anti-fingerprint black laminated	 Plywood with oak laminated
--	---	--

Due to the different configurations of monitors and printers, the appearance of the finishes may vary from the actual finish. To ensure that the chosen finishes meet your expectations, please refer to physical samples or contact a BUBLIING representative.

